

COMMON RATINGS

Step Angle	1.8 Degrees
Positional Accuracy	+/- 3% of full step
Number of Phases	Two
Temperature Rise	80C Maximum
Dielectric Strength	500V DC
Insulation Resistance	100M Ohm (500V DC)
Radial Play	0.025mm Max (450g Load)
Insulation Class	Class: B

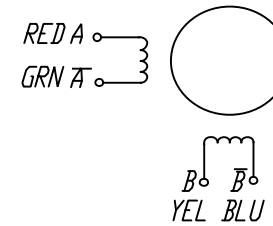

COLORS OF LEAD WIRES

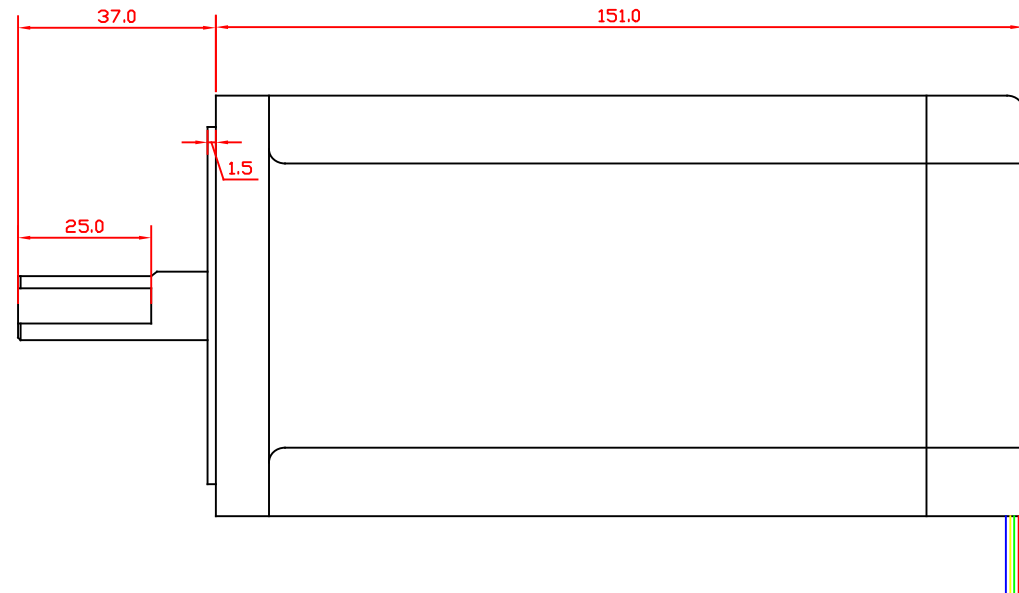
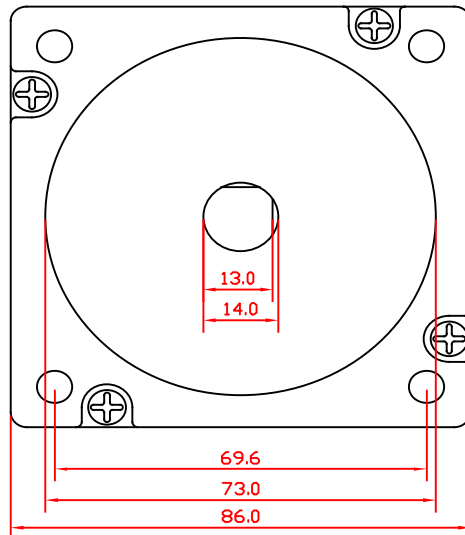

Part Number	Holding Torque Nm(+/- 10%)	Rated Current per phase A	Ph. resistance Ohms (+/-10%)	Inductance mH(+/-20%)	Mass kg
34HSX-412	12.0	6.0A/PHASE	0.58	8.2	2.7

16 MAY2013

www.CNCDirect.co.za

34HSX-412